

MOVABLE PARTITION

DESIGN
DYNAMOBEL

dynamobel



MOVABLE PARTITION

•

An office which becomes a conference room; a conference room which becomes a small auditorium or an auditorium which needs a small interpreter booth. In different areas, be they large or small, the call for multipurpose space is often essential. The Movable Partition is a compartmentalisation system consisting of independent modules which move along tracks which allow them to be set in different positions.

The modules can be handled by a single person, seal with the floor and ceiling by pressure, and come with magnetic strips to secure assembly between modules.

••

TABIQUE MÓVIL
Un despacho que se convierte en sala de reuniones; una sala de reuniones que se convierte en un pequeño auditorio o un auditorio que necesita de una pequeña cabina de traducción. Tanto en espacios reducidos como en superficies de gran extensión la necesidad de contar con espacios polivalentes muchas veces es imprescindible. El Tabique Móvil es un sistema de compartimentación compuesto por módulos independientes que se desplazan gracias a una guía que posibilita disponerlos en diferentes posiciones.

Los módulos pueden ser manejados por una sola persona, se sellan por presión al suelo y al techo, y cuentan con bandas magnéticas para asegurar el ensamblaje entre módulos.

••

MOBILE TRENNWAND
Ein Büro, das sich in einen Sitzungssaal verwandelt; ein Sitzungssaal, der zu einem kleinen Hörsaal umgestaltet wird, oder ein Hörsaal, der eine kleine Dolmetscherkabine benötigt. Sowohl in kleinen Räumen, als auch auf großen Flächen ist es oft unerlässlich, über Bereiche zu verfügen, die verschiedene Aufgaben erfüllen. Die Mobile Trennwand ist ein Unterteilungssystem aus unabhängigen Modulen, die dank eines Führungssystems verschoben und in verschiedene Positionen gebracht werden können.

Die Module können von einer Person allein bewegt werden. Sie werden mit Hilfe von Dichtungsdruck am Boden und an der Decke befestigt. Zudem verfügen sie über Magnetbänder zur optimalen Verbindung der einzelnen Module.





Each installation is completed with a track on the ceiling to withdraw the modules in orderly fashion.

The Movable Partition does not require a track on the floor, caters for both single and double suspension and reaches acoustic insulation levels of 43 dB (Applus-Spain, per UNE-EN ISO 717).

Cada instalación se completa con una guía en el techo que permite retirar de forma ordenada los módulos.

El Tabique Móvil no requiere guía en el suelo, ofrece la posibilidad de suspensión simple o doble y alcanza un aislamiento acústico de 43 dB (Applus-España, según norma UNE-EN ISO 717).

Alle Einrichtungen werden mit einer Führung an der Decke ergänzt, mit deren Hilfe die Module auf geordnete Weise zurückgezogen werden können.

Die Mobile Trennwand benötigt keinerlei Führungen auf dem Boden, verfügt nach Wahl des Kunden über einfache oder doppelte Aufhängung und garantiert eine akustische Isolierung von 43 dB (Applus-Spanien, Gemäß Norm UNE-EN ISO 717).



▼ The Movable Partition means that a single person can arrange space in a variety of possible ways.

El Tabique Móvil permite que sólo una persona pueda configurar un espacio de varias formas posibles. Dank der Mobilen Trennwand ist eine einzige Person in der Lage, den Raum auf vielseitige Weise zu gestalten.



COATINGS

REVESTIMIENTOS • VERKLEIDUNGEN

LACQUERED
LACADOS
LACKIERUNGEN

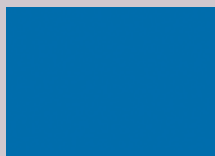

AK Electric blue
Azul eléctrico



HD Mustard yellow
Amarillo mostaza

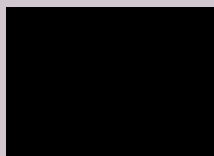

NE Black
Negro

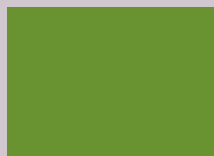

VV Spring green
Verde primavera



CV Bright red
Rojo vivo

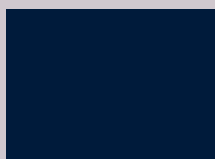

AJ Navy blue
Azul marino



BG Chocolate
Chocolate

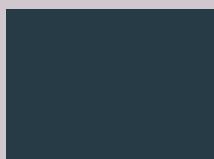

GF Deep grey
Gris profundo

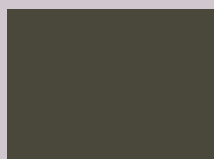

GV Greenish grey
Gris verdoso



CG Burgundy
Granate



AG Storm blue
Azul roto

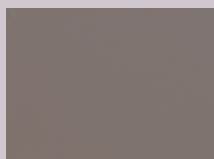

BT Mocha brown
Tostado

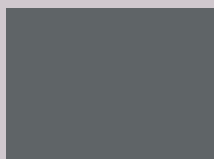

GA Anthracite grey
Gris antracita



VT Laurel green
Verde laurel



RO Red
Rojo



AF Ice blue
Azul gélido



BE Smoke
Humo

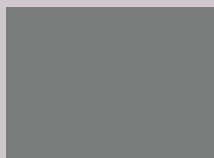

GE Mouse grey
Gris ratón



VG Khaki green
Verde caqui



CD Orange
Naranja



AE Grey blue
Azul grisáceo



BD Stone
Piedra

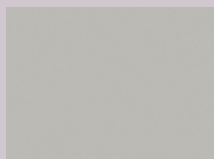

GC Light grey
Gris claro



VP Pistachio green
Verde pistacho



CC Vanilla
Vainilla

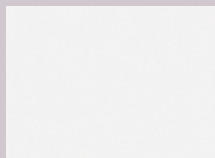

BA White
Blanco

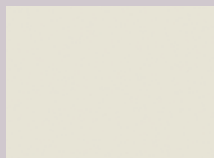

BC Cream white
Blanco crema

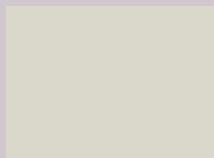

GD Off white
Blanco sucio

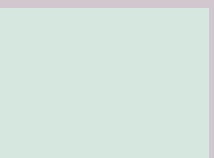

VA Sea blue
Aquamarina



CB Faded white
Blanco roto

WOOD
MADERA
ECHTHOLZ



RB White oak
Roble blanco



MB White s.g.
Mallada blanca

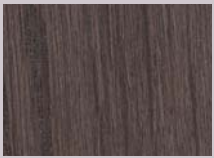

RG Grey oak
Roble gris



MG Grey s.g.
Mallada gris



RS Black oak
Roble negro

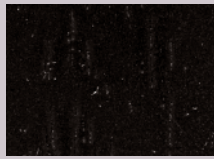

MS Black s.g.
Mallada negra



RC Cream oak
Roble crema



MC Cream s.g.
Mallada crema

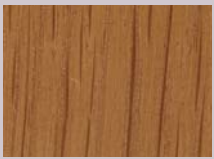

RD Honey oak
Roble miel

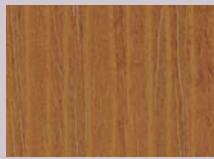

MD Honey s.g.
Mallada miel



RP Brown oak
Roble marrón

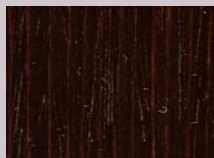

MP Brown s.g.
Mallada marrón

VINYL
VINILO
VINYL

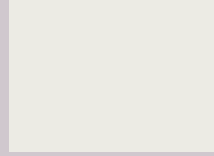

BA White
Blanco



02 Movinord white
Blanco Movinord



01 Cream
Crema



03 Sandstone
Arenisca



05 Moon grey
Gris luna



43 Aluminium
Aluminium



06 Blue
Azul



27 Beech
Haya



34 Maple
Maple



35 Decapé
Decapé



26 Cherry
Cerezo

STRUCTURE

ESTRUCTURA • STRUKTUR

POLYESTER PLAIN EPOXY
PINTURA EPOXY POLIESTER
EPOXY-POLYESTER-FARBE



AK Electric blue
Azul eléctrico



HD Mustard yellow
Amarillo mostaza



NE Black
Negro



VV Spring green
Verde primavera



CV Bright red
Rojo vivo

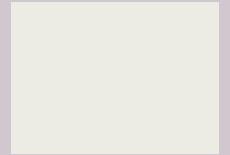

02 Movinord white
Blanco Movinord

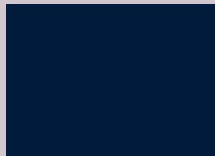

AJ Navy blue
Azul marino



BG Chocolate
Chocolate

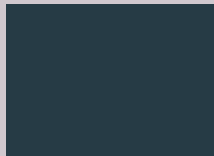

GF Deep grey
Gris profundo

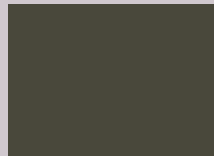

GV Greenish grey
Gris verdoso



CG Burgundy
Granate

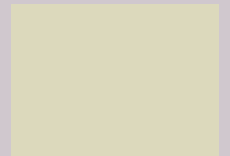

01 Cream
Crema



AG Storm blue
Azul roto

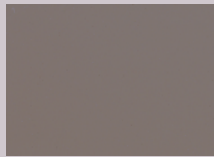

BT Mocha brown
Tostado



GA Anthracite grey
Gris antracita



VT Laurel green
Verde laurel



RO Red
Rojo



03 Sandstone
Arenisca



AF Ice blue
Azul gélido



BE Smoke
Humo



GE Mouse grey
Gris ratón



VG Khaki green
Verde caqui

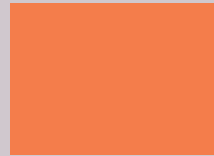

CD Orange
Naranja



05 Moon grey
Gris luna

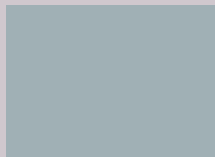

AE Grey blue
Azul grisáceo



BD Stone
Piedra

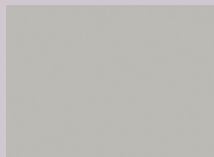

GC Light grey
Gris claro

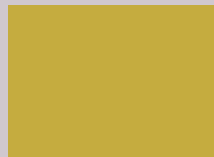

VP Pistachio green
Verde pistacho



CC Vanilla
Vainilla



06 Blue
Azul

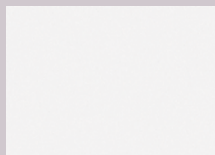

BA White
Blanco

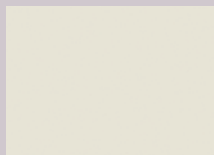

BC Cream white
Blanco crema

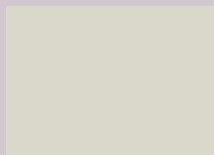

GD Off white
Blanco sucio

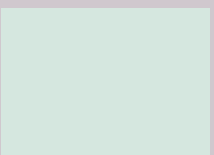

VA Sea blue
Aquamarina



CB Faded white
Blanco roto



29 Mica grey
Gris mica



04 Marengo
Marengo

METALLIE EPOXY
PINTURA METALIZADA
METALLACKIERUNG



GP Platinum grey
Gris platino



GG Graphite grey
Gris grafito



CHARACTERISTICS

CARACTERÍSTICAS • EIGENSCHAFTEN

Dimensions

- Module width:
 - Blind module: from 800 mm to 1,350 mm
 - Telescopic module: from 900 mm to 1,350 mm
 - Movable door module: 1,107 mm
 - Fixed door module: from 600 mm to 1,200 mm
- Standard module and floor-to-ceiling door heights:
 - Single suspension: from 2,500 mm to 3,200 mm
 - Double suspension: from 2,500 mm to 3,500 mm
- Height tolerance:
 - Finished floor: ± 10 mm
 - Finished ceiling: ± 10 mm
- Partition thickness: 100 mm
- Weight/m²: 45 kg

Frame

- Cold-formed steel inner frame machined for assembly with other components.
- Aluminium perimeter frame assembled onto both the steel frame and facing elements. Outer faces, mineral fibre and doors
- Floating panels on both sides of the frame, coated on inner face with asphalt sheeting.
- Particle-board panels, edged and laminated with semi-rigid vinyl coatings, cotton-gauze or cellulose-based vinyls, to choose from the Dynamobel finish range.
- Other options include noble woods, stratifieds, etc.
- Total thickness: 16 mm.
- Inner insulation with semi-rigid, 50-mm thick, 30/40 kg/m³ mineral fibre panelling.
- Movable, blind door leaf with frame and panels as on the rest of the partition. Dimensions: 811 x 1,968 x 100 mm.

Suspension of modules

- At one point or two points (single or double suspension) with elastic system and multi-directional carrying blocks fitted with bearings.
- Double suspension recommended for more than 5 or 6 modules.

Module fixture system

- Vertically via concave-convex magnetic strips with sextuple polarity and a force of attraction of 7/9 Kp/m. Closure via double-tongued, tongue and groove joints (arrow/slot).
 - Horizontally via mechanisms which move the labyrinth joints, closing to a pressure of 80/150 Kp/m. On floor and ceiling to prevent movement.
- Module release system
- Via soft-action crank with disconnection via same operation handle.

Track

- The track is a piece of extruded aluminium on which the carrying blocks travel. To offer a continuous glide without variations, the track joints have support components fitted with ball bearings.
- The track must be perfectly level and hung from a beam or other element capable of withstanding the weight of the partition. The track is normally fitted, levelled and soundproofed prior to the fitting of the false ceiling. When work is finished, the modules are hung via a pre-prepared section of demountable track. The minimum distance between the track and the beam is 250 mm.
- Dynamobel, SA does not supply the beam or strong frame required to hang the track.
- Dynamobel, SA does not supply the sound insulation between the false ceiling and the original ceiling beyond 500 mm above the false ceiling.
- Dynamobel, SA does not supply the housing recesses for parked modules.

Fittings

- Hinges and other metal fittings treated with the same paint, zinc, bluing coating, etc. depending on case.

Acoustic insulation

- Blind module $R_w = 43$ dB (Applus-Spain, per UNE-EN ISO 717).

Dimensiones

- Modulaci3n horizontal:
 - M3dulo ciego: de 800 mm a 1.350 mm
 - M3dulo telesc3pico: de 900 mm a 1.350 mm
 - M3dulo puerta m3vil: 1.107 mm
 - M3dulo puerta fija: de 600 a 1.200 mm
- Altura est3andar de m3dulos y puertas suelo/techo:
 - Suspensi3n simple: de 2.500 a 3.200 mm
 - Suspensi3n doble: de 2.500 a 3.500 mm
- Tolerancias en altura:
 - Suelo terminado: ± 10 mm
 - Techo terminado: ± 10 mm
- Espesor del tabique: 100 mm
- Peso/m²: 45 kg

Estructura

- Bastidor interno de acero conformado en fr3o y mecanizado para su ensamblaje con otros elementos.
- Bastidor perimetral de aluminio ensamblado al bastidor de acero y a su vez a los elementos de cierre.

Paramentos exteriores, lana de roca y puertas

- Paneles flotantes a ambos lados del bastidor, recubiertos en su interior con l3minas asf3lticas.
- Tableros de aglomerado de part3culas de madera, canteados y aplacados con revestimientos vin3licos semirr3gidos, vinilos con soporte celul3sico o de algod3n, a elegir dentro de la colecci3n de acabados Dynamobel.
- Otras opciones alternativas pueden ser maderas nobles, estratificados, etc.
- Espesor total: 16 mm.
- Aislante interior con paneles semirr3gidos de lana mineral de 30/40 kg/m³ de densidad y 50 mm de espesor.
- Hoja de puerta ciega m3vil, con bastidor y paneles de iguales caracter3sticas que el resto del tabique. Dimensiones 811 x 1.968 x 100 mm.

Suspensi3n de m3dulos

- En un punto o en dos (suspensi3n simple o doble), con sistema el3stico y carros de rodadura multidireccionales con rodamientos.
- Para m3s de 5 o 6 m3dulos, se recomienda la suspensi3n doble.

Sistema de fijaci3n de m3dulos

- Verticalmente, a trav3s de bandas magn3ticas wc3ncavo-convexas, de sextuple polaridad, con una fuerza de atracci3n de 7/9 kp/ml. Cierre con juntas machihembradas de doble lengüeta tipo flecha/ranura.
 - Horizontalmente, a trav3s de mecanismos que desplazan las juntas laber3nticas, sellando con presi3n de 80/150 kp/ml. Sobre el suelo y el techo para evitar desplazamientos
- Sistema de liberaci3n de m3dulos
- Con manivela de giro y suave movimiento, de desconexi3n a trav3s del mismo tirador de accionamiento.

Guía

- Es una pieza de aluminio extrusionado por donde discurren los carros de rodadura. Sus encuentros, para seguir un deslizamiento continuo y sin oscilaciones, van provistos de unos elementos soporte con rodamientos a bolas incorporados.
- Deberá quedar perfectamente nivelada y colgada a una viga u otro elemento que resista al peso del tabique. Su colocación, nivelación e insonorización se realizará normalmente antes de la colocación del falso techo. Terminada la obra, se cuelgan los módulos a través de una zona de guía desmontable que previamente se ha preparado. La medida mínima de la guía a la viga es de 250 mm.
- Dynamobel, SA no incluye la viga o estructura de robustez suficiente para el colgado de dicha guía.
- Dynamobel, SA no incluye la insonorización entre el falso techo y el forjado por encima de los 500 mm sobre el falso techo.
- Dynamobel, SA no incluye los nichos de alojamiento para los módulos aparcados.

Accesorios

- Bisagras y resto de accesorios metálicos tratados con los mismos recubrimientos de pintura, zincados, pavonados, etc. según casos.

Aislamiento acústico

- Módulo ciego $R_w = 43$ dB (Applus-España, según norma UNE-EN ISO 717)

Maße

- Modulbreite:
 - Nicht transparentes Modul: 800 mm bis 1.350 mm
 - Teleskop-Modul: 900 mm bis 1.350 mm
 - Mobiles Türmodul: 1.107 mm
 - Feststehendes Türmodul: 600 mm bis 1.200 mm
- Standardhöhe der Module und Türen vom Boden bis zur Decke:
 - Einfache Aufhängung: 2.500 mm bis 3.200 mm
 - Doppelte Aufhängung: 2.500 mm bis 3.500 mm
- Höhenausgleich:
 - Boden: ± 10 mm
 - Decke: ± 10 mm
- Dicke der Trennwand: 100 mm
- Gewicht/m²: 45 kg

Aufbau

- Innen liegendes Gestell aus kaltgeformtem Stahl, mit mechanischer Bearbeitung zur Verbindung mit anderen Elementen.
- Umlaufendes Aluminiumprofil, das einerseits mit dem Stahlgestell und andererseits mit den Verschlusselementen verbunden ist.

Außenflächen, Mineralwolle und Türen

- Schwimmend verlegte Paneele an beiden Gesellenseiten, im Inneren mit Asphaltfolien verkleidet.
- Platten aus Pressholz, Kantenbesäumung und Beschichtungen aus halbstarrem Vinyl, Vinyl mit einer Trägerschicht aus Zellulose oder Baumwolle, wählbar aus den Oberflächen der Dynamobel-Kollektion. Weitere Optionen für die Verkleidung sind edle Hölzer, Laminate usw. Gesamtdicke: 16 mm.
- Innenisolierung mit halbstarren Platten aus Mineralwolle mit einer Dichte von 30/40 kg/m³ und einer Dicke von 50 mm.
- Nicht transparentes, mobiles Türblatt, mit Rahmen und Paneelen derselben Art wie diejenigen der übrigen Trennwand Abmessungen 811 x 1.968 x 100 mm.

Aufhängung der Module

- Ein- oder Zwei-Punkt-Aufhängung (einfache oder doppelte Aufhängung) mit elastischem System und Mehrweg-Führungsschlitten mit Rollenlagern.
- Für mehr als 5 oder 6 Module wird die doppelte Aufhängung empfohlen.

Befestigungssystem der Module

- Vertikal mit Hilfe von konkaven/konvexen sechspoligen Magnetbändern mit einer Anziehungskraft von 7/9 kp/ml. Verschluss mit Feder-Nut-Verbindungen mit doppelzüngiger bündiger Überlappverbindung vom Typ Pfeil/Nut.
- Horizontal über Mechanismen, die die Labyrinthdichtungen verschieben, wodurch ein Dichtungsdruck von 80/150 kp/ml auf den Boden und die Decke entsteht, um ungewollte Verschiebungen zu verhindern.

Lösungssystem der Module

- Mit Handkurbelkurbel und sanfter Auskupplungsbewegung über den Kurbelgriff.

Führung

- Es handelt sich um ein Teil aus extrudiertem Aluminium, durch das sich die Führungsschlitten bewegen. Um eine fortlaufendes schwingungsfreies Gleiten zu garantieren, verfügen ihre Verbindungsstellen über Aufnahmeelemente mit integrierten Kugellagern.
- Die Führung muss perfekt nivelliert an einem Balken oder an einem anderen Element, das dem Trennwandgewicht standhält, aufgehängt werden. Das Anbringen, Nivellieren und die Schalldämpfung der Führung wird im Normalfall vor dem Anbringen der abgehängten Decke vorgenommen. Sobald der Bau beendet ist, werden die Module über einen zuvor eingerichteten, demontierbaren Führungsbereich eingehängt. Der Mindestabstand zwischen der Führung und dem Balken beträgt 250 mm.
- Der Balken oder die Struktur mit ausreichender Widerstandsfähigkeit für das Anbringen dieser Führung gehört nicht zum Lieferumfang von Dynamobel, SA.
- Die Schalldämmung zwischen der abgehängten Decke und der Geschossdecke von mehr als 500 mm über der abgehängten Decke gehört nicht zum Lieferumfang von Dynamobel, SA.
- Die Aufnahmenischen für die geparkten Module gehören nicht zum Lieferumfang von Dynamobel, SA.

Zubehör

- Scharniere sowie sonstiges Metallzubehör mit Lackierung, Verzinkung, Brünierung usw. behandelt, je nach Bedürfnis.

Akustische Isolierung

- Nicht transparentes Modul $R_w = 43$ dB (Applus-Spanien, gemäß Norm UNE-EN ISO 717).

MODULES AND TRACKS

MÓDULOS Y GUÍAS • MODULE UND FÜHRUNGEN

Double suspension telescopic module.

Módulo telescópico suspensión doble.
Teleskop-Modul doppelte Aufhängung.

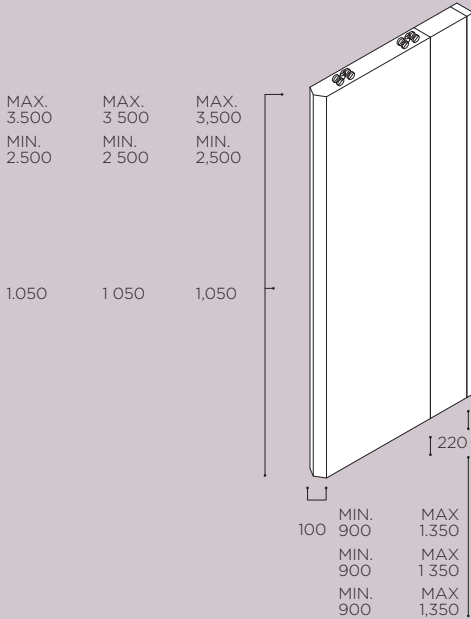

Double suspension blind module.

Módulo ciego suspensión doble.
Nicht transparentes Modul doppelte Aufhängung.



Single suspension telescopic module.

Módulo telescópico suspensión simple.
Teleskop-Modul einfache Aufhängung.

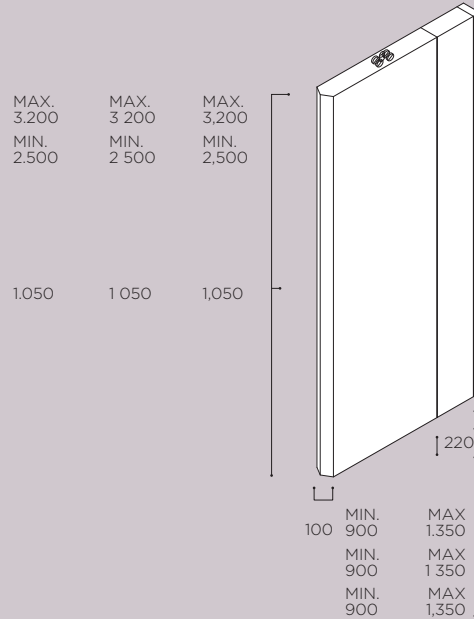

Single suspension blind module.

Módulo ciego suspensión simple.
Nicht transparentes Modul einfache Aufhängung.

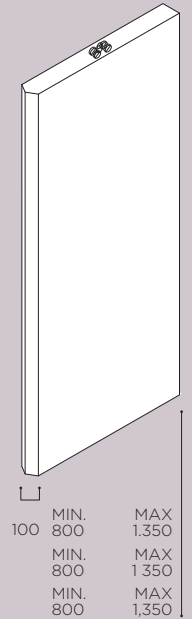

Door module.

Módulo puerta.
Türmodul.

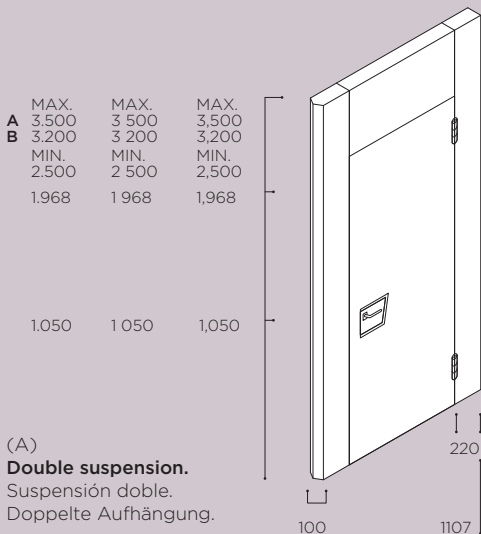

(A)
Double suspension.
Suspensión doble.
Doppelte Aufhängung.

(B)
Single suspension.
Suspensión simple.
Einfache Aufhängung.

Single guide suspension (mono-directional) [1].

Double guide suspension (multi-directional) [2].

Suspensión guía simple (monodireccional) [1].
Suspensión guía doble (multidireccional) [2].
Aufhängung einfache Führung (einweg) [1].
Aufhängung doppelte Führung (mehrweg) [2].

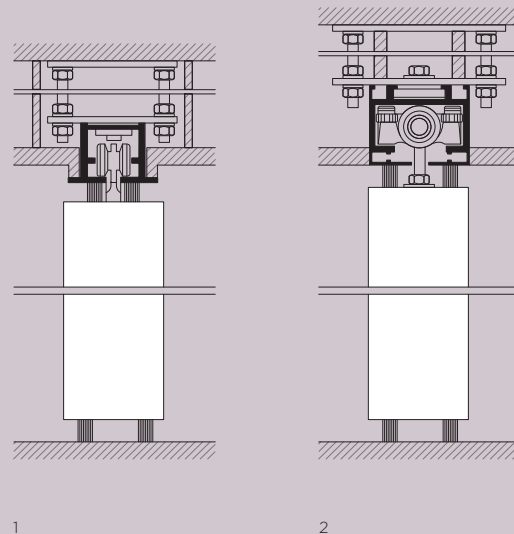

PARKING

APARCAMIENTO • PARKNISCHEN

EXAMPLES • EJEMPLOS • BEISPIELE

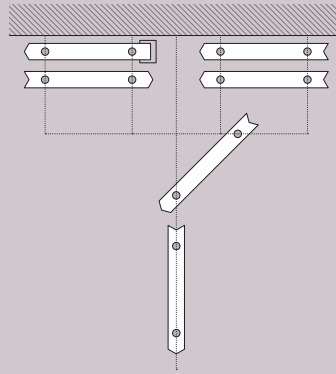
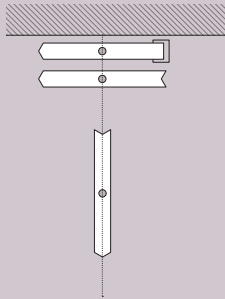

Parking.
Aparcamiento.
Parknische.

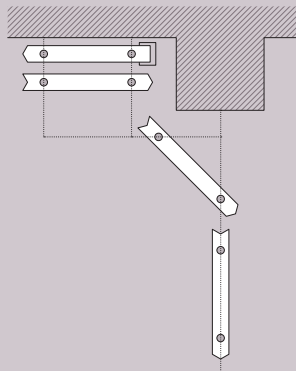
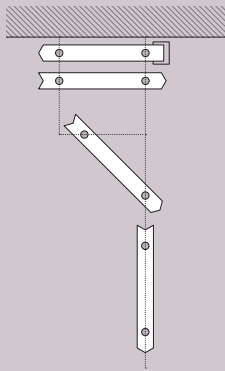

Single suspension.
Suspensión simple.
Einfache Aufhängung.

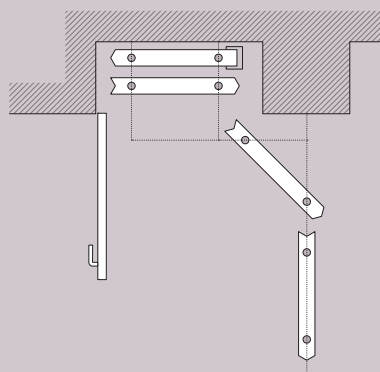

Double suspension.
Suspensión doble.
Doppelte Aufhängung.

Dynamobel S.A.

CENTRAL INBOX, SPAIN

Ctra. Madrid Km 24
31350 Peralta
Navarra, Spain
T +34 948 750 000
F +34 948 750 750
info@dynamobel.com

CENTRAL BOX, SPAIN

Ctra. de Guipúzcoa Km 7,5
Apdo. 1074 31080 Pamplona
Navarra, Spain
T +34 948 303 171
F +34 948 302 581
info@dynamobel.com

DESIGN ALDRICH
PHOTOGRAPHY LUIS PRIETO

KJM/CAT/046/11

© DYNAMOBEL. ALL RIGHTS RESERVED.
REPRODUCTION OF THE WHOLE OR ANY PART
OF THE CONTENTS IS PROHIBITED.

We are breaking out of the rigid structure through which many companies in the sector impose standard solutions without questioning the constraints these place on good ideas.

Our aim is to venture beyond, stay one step ahead, because we believe that good ideas deserve more than a simple, all-embracing solution.

We work to understand designers and look into ways of solving their work, providing a suitable balance between customisation and industrialisation. Good ideas do not compromise form or function. We will defend that come what may.

Nos salimos de la estructura rígida de muchas empresas del sector en el que se imponen soluciones estándar sin cuestionarse las limitaciones que éstas imponen en las buenas ideas.

Nuestro propósito es ir más allá, un paso por delante, porque creemos que las buenas ideas merecen más que una solución masiva.

Trabajamos por entender a los creadores y explorar formas de resolver sus obras, que ofrezcan un adecuado equilibrio entre personalización e industrialización. Las buenas ideas no comprometen forma ni función. Defenderemos esto ante todo.

Wir haben uns von den starren Strukturen gelöst, in denen viele Unternehmen des Sektors verharren, indem sie Standardlösungen bieten, ohne sich dabei die Frage zu stellen, in welchem Maße diese die Umsetzung guter Ideen einschränken.

Wir haben es uns zum Ziel gesetzt, weiter zu denken und immer einen Schritt voraus zu sein, denn wir sind überzeugt, dass eine gute Idee mehr verdient als einfach nur eine vorgefertigte Lösung.

Wir bemühen uns, die Menschen, die Ideen entwickeln, zu verstehen, und versuchen, Mittel und Wege zu finden, um diese Ideen zu verwirklichen, ohne dabei jedoch ein angemessenes Gleichgewicht zwischen Individualität und Standardisierung aus dem Auge zu verlieren. Gute Ideen beeinträchtigen weder Form noch Funktion. Diesen Standpunkt vertreten wir mit allem Nachdruck.

